

BKS5990FW6

60 cm, WINE CELLAR, OFW Model

BUILT-IN

BRILLIANCE® SERIE

Fhiaba

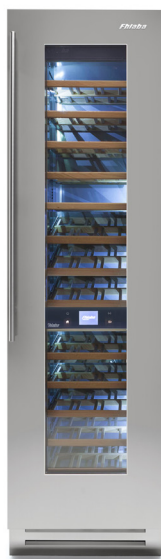

FEATURES

- Made in Italy.
- Aisi 304 stainless steel body.
- Stainless steel interior finish
- Antibacterial stainless steel interior.
- Provent ventilation system encourages uniform distribution of cold air in all fridge compartments by laterally circulation air.
- Equilance: dual - movemenet patented hinge with self - balancing movement ensures stability and resistance.
- Optiview: multi - LED light array (top and side interior) provides brilliant illumination to the entire interior.
- Smart touch TFT display
- Acoustic and visual signals
- Total no frost 100% automatic system
- Insulated variavle speed compressors manteins precision temperature control with low vibration.
- Sabbath mode
- Front and rear adjustable feet up to 25 mm.
- Two indipendent climatic zone.
- Deep capacity within a standard depth is achieved by a side - mounted evaporators, wich leaves grater interior space.
- Full range of models and configurations (45, 60, 75 and 90 cm). Can easily be combined and configured with other Fhiaba fridge, freezer, wine cellar models to fit your kitchen needs.
- Triple-pane, bronzed glass door guarantees maximun protection from harmful UV light rays.
- Soft - close mechanisms on every oak wine rack.
- Humidity control

GENERAL PROPERTIES

Reversible door	NO
Equilance	YES
SoftClosing Runner	NO
Low vibration	YES
Optiview (LED light spots)	YES
Shelves	13
Slide-out shelves	YES
Type of shelves	WOOD
Door Bins	
Fridge drawers type	
Fresco/LowTemp Drawers	
Bottom drawers	
Full Extension shelves 90° door opening	
Full Extension drawers 90° door opening	NO
Defrost Process	AUTOMATIC
Ice maker with water filter	NO
Door Open Alarms	YES
Humidity control	YES
Active carbon filter	YES
Air filter control	NO
Shopping Fridge	NO
Shopping Freezer	NO
Power Failure Function	YES

BKS5990FW6

60 cm, WINE CELLAR, OFW Model

BUILT-IN

BRILLIANCE® SERIE

PRODUCT DETAIL

Fhiaba

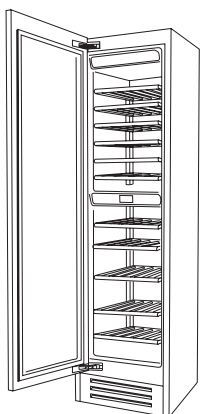

1D | 2M

wine cellar

D = door

M = separate microclimates

CAPACITY

Volume Compartment 1 (L)	352
Volume Compartment 2 (L)	
Volume Compartment 3 (L)	
Total Net Volume (L)	352
Total Gross Volume (L)	364
Compartment 1 / Upper wine cellar capacity (bottles)	48
Compartment 2 / Lower wine cellar capacity (bottles)	30
Compartment 3 / Bottom wine cellar capacity (bottles)	

TECHNICAL DETAILS

Absorbed power (W)	175
Total absorbed current (A)	1.2
Voltage (V)	220-240V
Frequency (Hz)	50-60 Hz
Power Cord Length (mm)	2
Plug Type	Tipo F Schuko 16A
Climatic class	SN/T
Noise level (dB)	41
Refrigerant (gas)	R600a
Water connection / female attachment	

EFFICIENCY

New Energy Label class	G
Energy consumption (kWh/year)	169

DIMENSIONS & WEIGHT

Height of the product (closed weels) (mm)	2050
Adjustable feet height (mm)	25
Width of the product (mm)	599
Depth of Product without handle (mm)	640
Wall cavity height (mm)	2064
Wall cavity width (mm)	600
Wall cavity depth (mm)	650
Net Weight (kg)	152
Gross Weight (kg)	172

TEMPERATURE RANGES

Climatic compartments	2
Compartment 1 / Upper temperature (°C)	from 4 to 18
Compartment 2 / Middle temperature (°C)	from 4 to 18
Low temp zone	NO
Compartment 3 / Low temperature (°C)	
Dual zone	NO

BKS5990FW6

60 cm, WINE CELLAR, OFW Model

BUILT-IN

BRILLIANCE® SERIE

PRODUCT SPECIFICATIONS AND DIMENSIONS

Fhiaba

FRONT VIEW

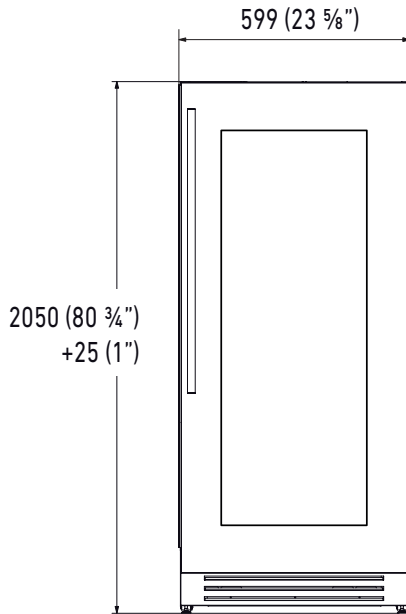

SIDE VIEW

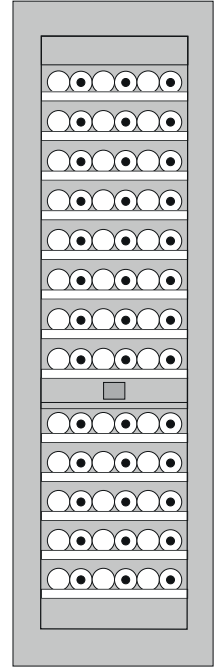
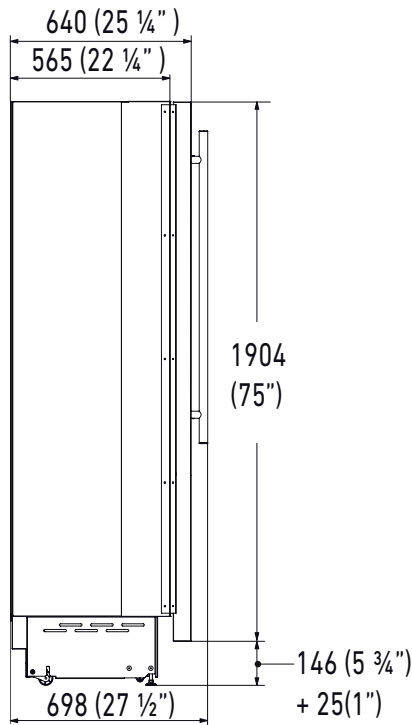

TOP VIEW, HINGE 105°

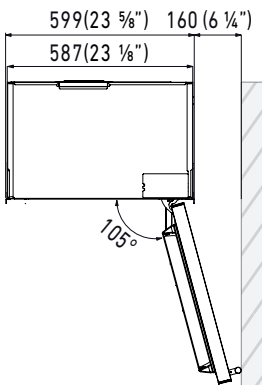

TOP VIEW, HINGE 90°

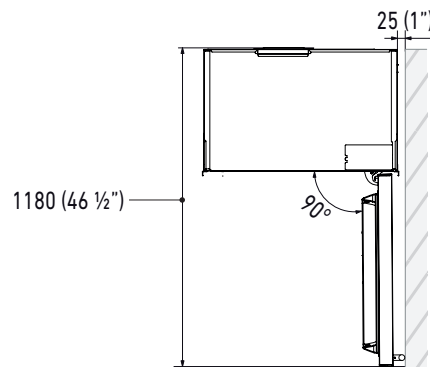

PLINTH SIZE

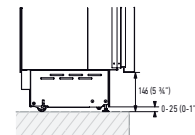

i For installation specifications, please consult with Fhiaba. For optimum installation, we recommend using the actual product as the best guide.

i Based on the adjustment of the feet and the height of the panel from the floor, the customer defines the perforated plinth to be installed on the equipment.

BKS5990FW6

60 cm, WINE CELLAR, OFW Model

BUILT-IN

BRILLIANCE® SERIE

NICHE SPECIFICATIONS AND DIMENSIONS

Fhiaba

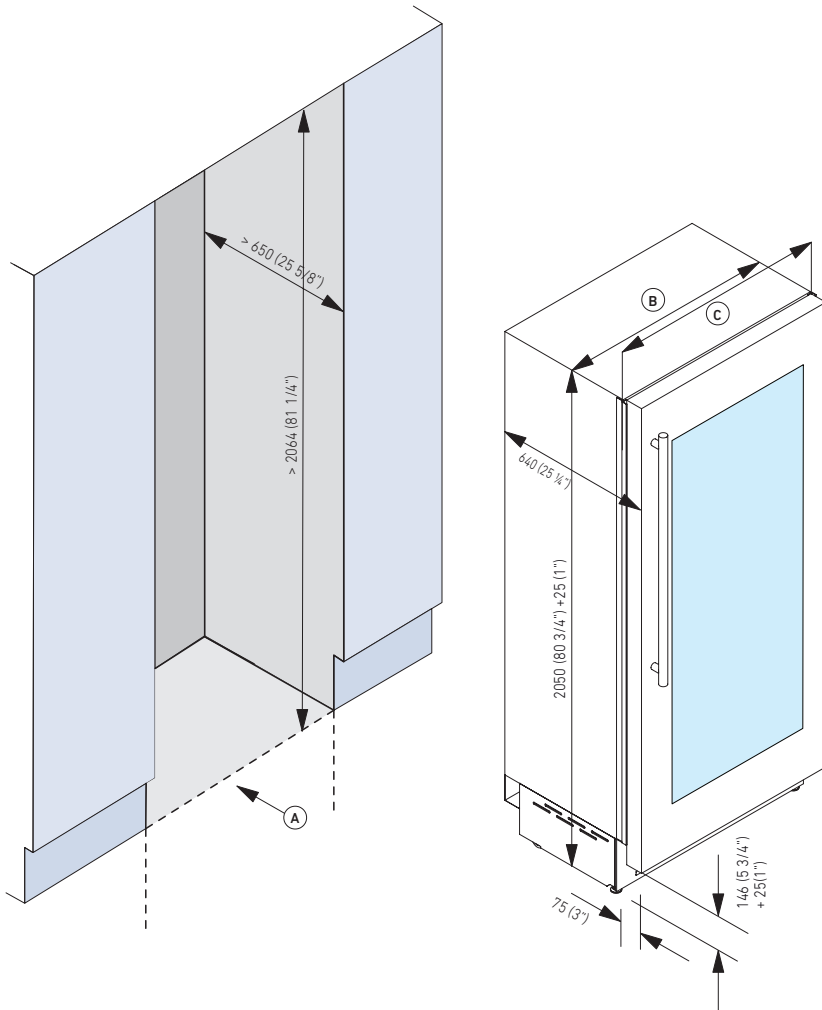

TECHNICAL DATA	
Niche Width A (mm)	600
Unit Width B (mm)	587
Unit Width with lateral frames C (mm)	599

Electrical and Water connection



BKS5990FW6

60 cm, WINE CELLAR, OFW Model

BUILT-IN

BRILLIANCE® SERIE

INSTALLATION INFORMATION

Fhiaba

Niche dimensions for combined installation

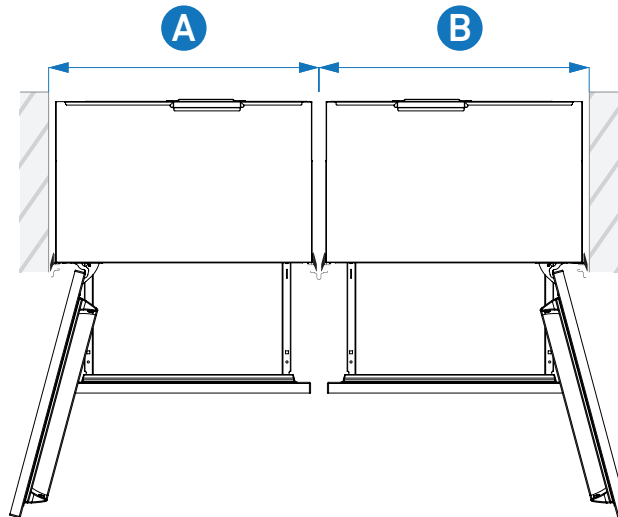

		A			
	unit size	45	60	75	90
B	45	90 cm	105 cm	120 cm	135 cm
	60	105 cm	120 cm	135 cm	150 cm
	75	120 cm	135 cm	150 cm	165 cm
	90	135 cm	150 cm	165 cm	180 cm

ACCESSORIES

- Stainless steel sides panels
- Glass door
- Joining kit
- Stainless steel portal for freestanding
- Extra length anti-tipping kit
- Anticondensation kit
- Cleaning kit
- Active carbon filter
- FLD - Fhiaba Link Device
- Front ventilation kit
- Painting
- 90° Door stop
- Wine kit
- Cheese drawer
- Set of knives
- Prosciutteria kit
- Bottle trap
- Sigar drawer
- Beverage drawer
- Beverage shelf
- Beverage removable shelf
- Chocolate kit

 For installation specifications, please consult with Fhiaba. For optimum installation, we recommend using the actual product as the best guide.

   
www.fhiaba.com