

KS901TST3

90 cm, FRIDGE AND FREEZER, 1T Model

BUILT-IN

CLASSIC® SERIES

Fhiaba



FEATURES

- Made in Italy
- TriMode™: Total Flexibility, make the bottom drawer a refrigerator, fresh food space, or freezer with the control menu
- OptiView™: OptiView LED lights
- EventLift™: Easily rearrange the shelving without removal using the EvenLift system
- ProVent™: Uniform air circulation maintains consistent temperatures throughout the appliance resulting in better food preservation
- Antibacterial Stainless Steel Interiors Drawers: Achieve the highest food quality by storing food in the stainless steel interior drawer that shields against the spread of bacteria
- Total No Frost: Temperature control helping mitigate cooling loss when opening the refrigerator door. No more frost build-up that requires defrosting

GENERAL PROPERTIES

Equilance Hinge	YES
Soft-Closing Glides	YES
Low Vibration	YES
OptiView (Led Light Spots)	YES
Shelves	4
Type Of Shelves	Glass
Door Bins	3
Fridge Interior Drawers	2
Freezer Drawers	1
Evenlift Shelves	YES
Full Extension Shelves 90° Door Opening	NO
Full Extension Drawers 90° Door Opening	YES
Defrost Process	AUTOMATIC
Ice Maker With Water Filter	NO
Door Open Alarms	YES
Shopping Fridge	YES
Shopping Freezer	YES
Power Failure Alert	YES
Water Dispenser With Water Filter	NO

KS901TST3

90 cm, FRIDGE AND FREEZER, 1T Model
BUILT-IN

CLASSIC® SERIES

PRODUCT DETAIL

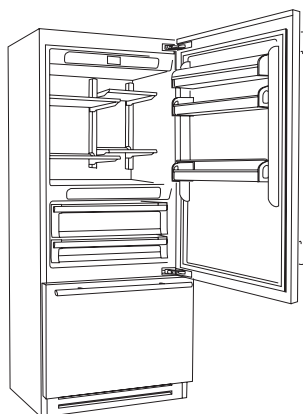

Fhiaba

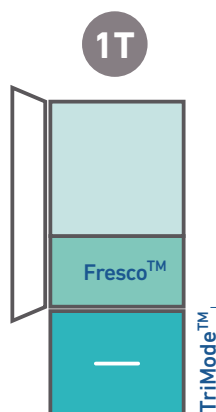

1D | 1BD | 3M

D = door
BD = drawer
M = separate microclimates

CAPACITY

Volume Compartment 1 (L)	268
Volume Compartment 2 (L)	128
Volume Compartment 3 (L)	131
Total Net Volume (L)	527
Total Gross Volume (L)	551
Compartment 1 / Upper wine cellar capacity (bottles)	/
Compartment 2 / Lower wine cellar capacity (bottles)	/
Compartment 3 / Bottom wine cellar capacity (bottles)	/

TECHNICAL DETAILS

Total absorbed current (A)	2
Voltage (V)	220-240V
Frequency (Hz)	50/60 Hz
Power Cord Length (mm)	2
Plug Type	Tipo F (Schuko) 16A IEC13
Climatic class	SN/T
Noise level (dB)	41
Refrigerant (gas)	R600a
Water connection / female attachment	/

EFFICIENCY

New Energy Label class	E
Energy consumption (kWh/year)	315

DIMENSIONS & WEIGHT

Height of the product (closed weels) (mm)	2050
Adjustable feet height (mm)	25
Width of the product (mm)	899
Depth of Product without handle (mm)	635
Wall cavity height (mm)	2064
Wall cavity width (mm)	900
Wall cavity depth (mm)	650
Net Weight (kg)	209
Gross Weight (kg)	230

TEMPERATURE RANGES

Climatic compartments	3
Compartment 1 / Upper temperature (°C)	from 2 to 8
Compartment 2 / Middle temperature (°C)	from -2 to 2
Low temp zone	NO
Compartment 3 / Low temperature (°C)	from -15 to -22
Dual zone	NO

ACCESSORIES

- Stainless steel sides panels
- Joining kit
- Stainless steel portal for freestanding
- Extra lenght anti-tipping kit
- Anticondensation kit
- Double EvenLift shelves
- Cleaning kit
- FLD - Fhiaba Link Device
- Front ventilation kit
- Painting
- 90° Door stop

KS901TST3

90 cm, FRIDGE AND FREEZER, 1T Model

BUILT-IN

CLASSIC® SERIES

PRODUCT SPECIFICATIONS AND DIMENSIONS

Fhiaba

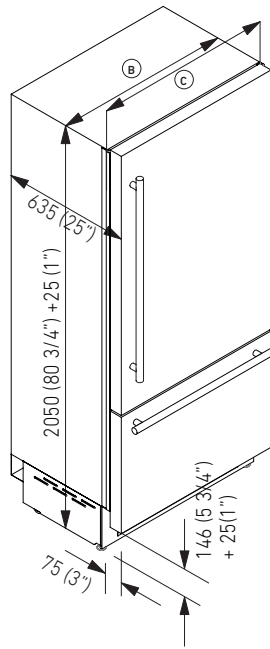
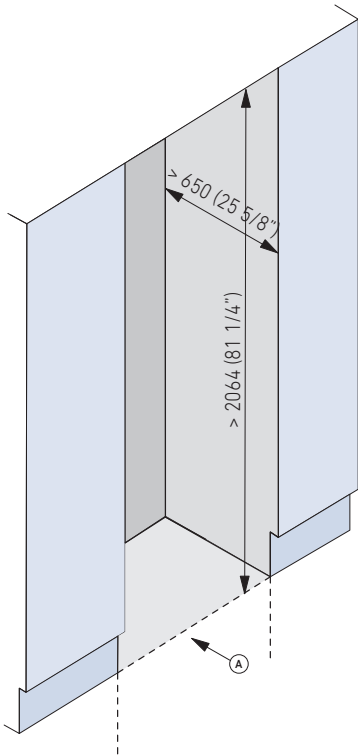

FRONT VIEW

SIDE VIEW

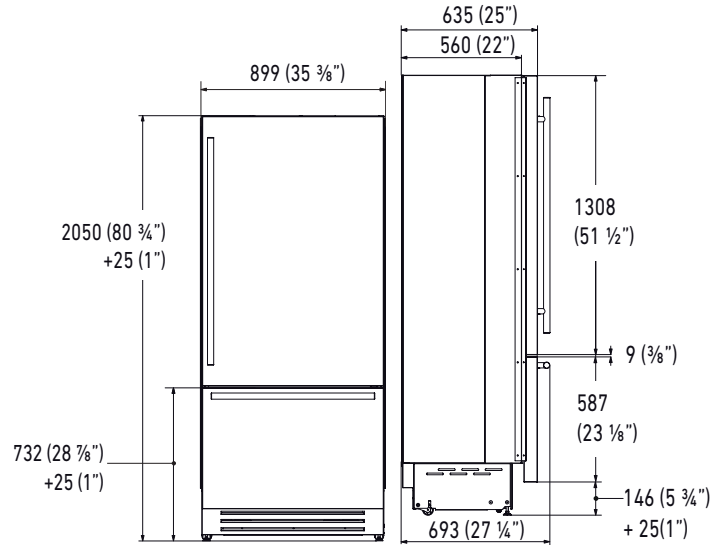

TECHNICAL DATA	
Niche Width A (mm)	900
Unit Width B (mm)	887
Unit Width with lateral frames C (mm)	899

TOP VIEW, HINGE 105°

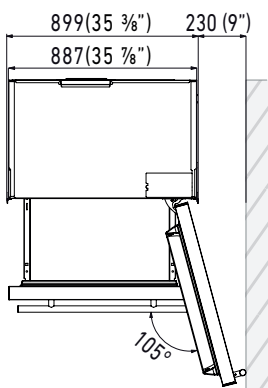

TOP VIEW, HINGE 90°

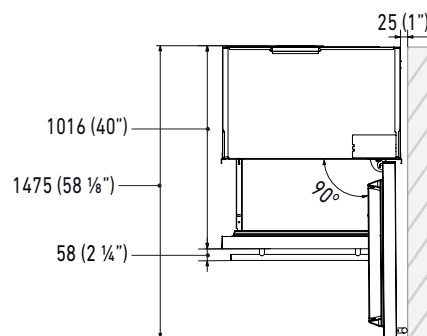

PLINTH SIZE

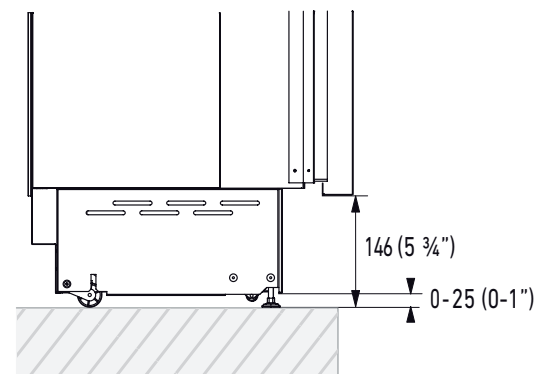

i For installation specifications, please consult with Fhiaba. For optimum installation, we recommend using the actual product as the best guide.

i Based on the adjustment of the feet and the height of the panel from the floor, the customer defines the perforated plinth to be installed on the equipment.

KS901TST3

90 cm, FRIDGE AND FREEZER, 1T Model

BUILT-IN

CLASSIC® SERIES

PRODUCT SPECIFICATIONS

Fhiaba

Electrical Connection

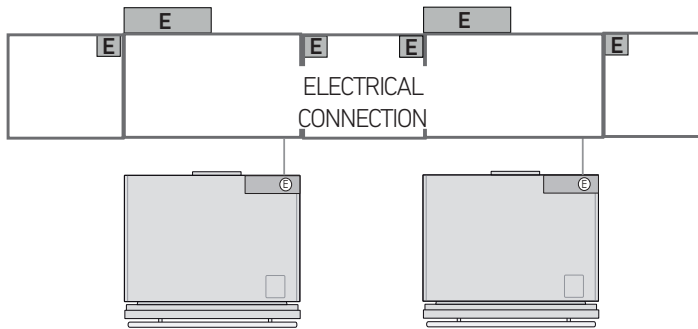

Electrical and water connections (if applicable) should be reachable without having to uninstall the appliance. If the connections must be made directly behind the appliance then it is recommended to recess those connections.

IMPORTANT: do not put the water shut-off valve behind the appliance where it will be inaccessible.

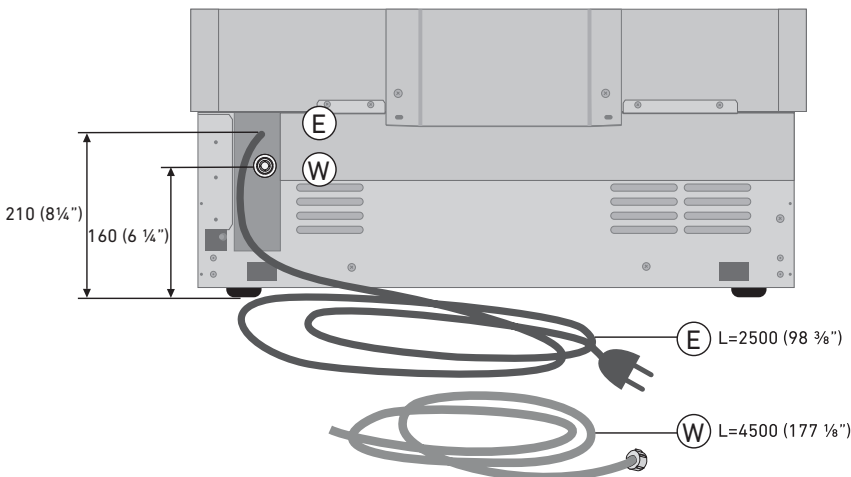
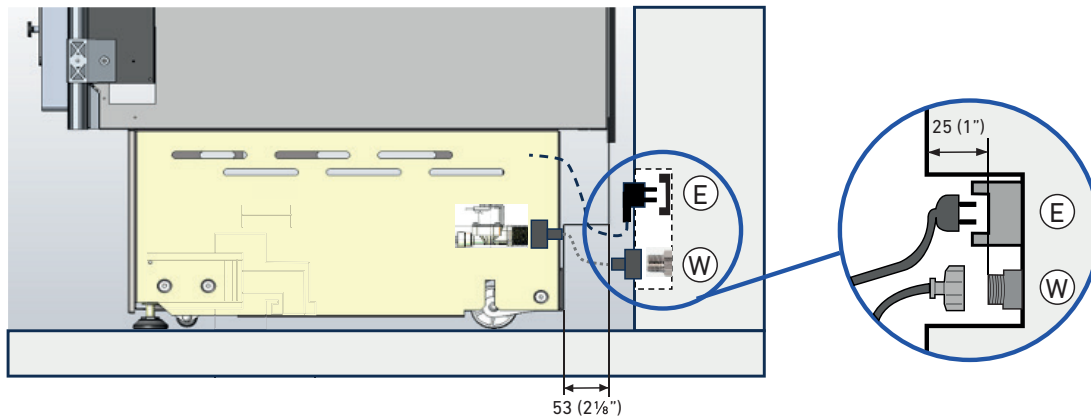

For installation specifications, please consult with Fhiaba. For optimum installation, we recommend using the actual product as the best guide.



www.fhiaba.com