

XS5991TWT3

60 cm, DUAL COMPARTMENT WINE CELLAR, 1T Model

BUILT-IN

X-PRO® SERIE

Fhiaba



FEATURES

- Made in Italy.
- Aisi 304 stainless steel body.
- Stainless steel interior finish
- Antibacterial stainless steel interior.
- Provent ventilation system encourages uniform distribution of cold air in all fridge compartments by laterally circulation air.
- Equilance: dual - movemenet patented hinge with self - balancing movement ensures stability and resistance.
- Optiview: multi - LED light array (top and side interior) provides brilliant illumination to the entire interior.
- Smart touch TFT display
- Acoustic and visual signals
- Total no frost 100% automatic system
- Insulated variavle speed compressors manteins precision temperature control with low vibration.
- Sabbath mode
- Front and rear adjustable feet up to 25 mm.
- Three independent climatic zone.
- Deep capacity within a standard depth is achieved by a side - mounted evaporators, wich leaves grater interior space.
- Full range of models and configurations (18", 24", 30" and 36"). Can easily be combined and configured with other Fhiaba fridge, freezer, wine cellar models to fit your kitchen needs.
- Triple-pane, bronzed glass door guarantees maximun protection from harmful UV light rays.
- Soft - close mechanisms on every oak wine rack.
- Humidity control
- Ambra light LED: not interact at the molecular level with the wine and not contains ultraviolet rays.

GENERAL PROPERTIES

Reversible door	NO
Equilance	YES
SoftClosing Runner	YES
Low vibration	YES
Optiview (LED light spots)	YES
Shelves	9
Slide-out shelves	YES
Type of shelves	WOOD
Door Bins	
Fridge drawers type	
Fresco/LowTemp Drawers	
Bottom drawers	1
Full Extension shelves 90° door opening	YES
Full Extension drawers 90° door opening	NO
Defrost Process	AUTOMATIC
Ice maker with water filter	NO
Door Open Alarms	YES
Humidity control	YES
Active carbon filter	YES
Air filter control	NO
Shopping Fridge	NO
Shopping Freezer	NO
Power Failure Function	YES

XS5991TWT3

60 cm, DUAL COMPARTMENT WINE CELLAR, 1T Model

BUILT-IN

X-PRO® SERIE

PRODUCT DETAIL

Fhiaba

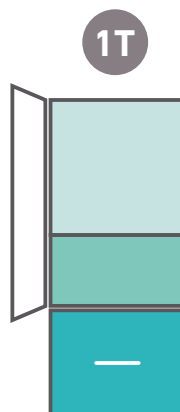
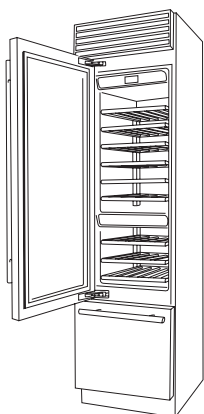

1D | 1BD | 3M

D = door

BD = drawer

M = separate microclimates

CAPACITY

Volume Compartment 1 (L)	147
Volume Compartment 2 (L)	76
Volume Compartment 3 (L)	77
Total Net Volume (L)	300
Total Gross Volume (L)	315
Compartment 1 / Upper wine cellar capacity (bottles)	36
Compartment 2 / Lower wine cellar capacity (bottles)	18
Compartment 3 / Bottom wine cellar capacity (bottles)	

TECHNICAL DETAILS

Absorbed power (W)	
Total absorbed current (A)	1.8
Voltage (V)	220-240V
Frequency (Hz)	50-60 Hz
Power Cord Length (mm)	2
Plug Type	Schuko 16A
Climatic class	SN/T
Noise level (dB)	41
Refrigerant (gas)	R600a
Water connection / female attachment	-

EFFICIENCY

New Energy Label class	
Energy consumption (kWh/year)	

DIMENSIONS & WEIGHT

Height of the product (closed weels) (mm)	2120
Adjustable feet height (mm)	25
Width of the product (mm)	599
Depth of Product without handle (mm)	635
Wall cavity height (mm)	2134
Wall cavity width (mm)	600
Wall cavity depth (mm)	650
Net Weight (kg)	162
Gross Weight (kg)	182

TEMPERATURE RANGES

Climatic compartments	3
Compartment 1 / Upper temperature (°C)	from 4 to 18
Compartment 2 / Middle temperature (°C)	from 4 to 18
Low temp zone	NO
Compartment 3 / Low temperature (°C)	from 4 to 18
Dual zone	NO

XS5991TWT3

60 cm, DUAL COMPARTMENT WINE CELLAR, 1T Model

BUILT-IN

X-PRO® SERIE

PRODUCT SPECIFICATIONS AND DIMENSIONS

Fhiaba

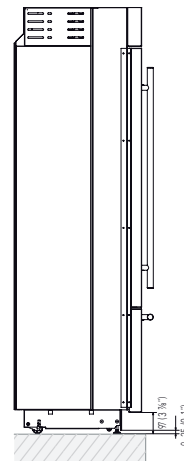
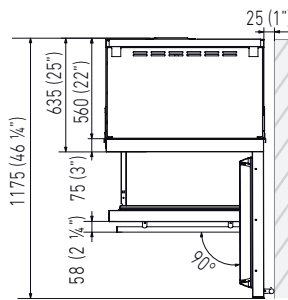
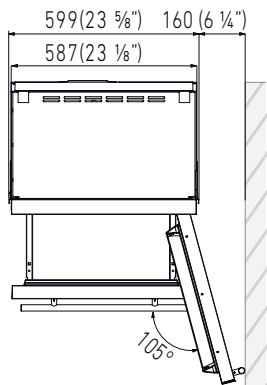
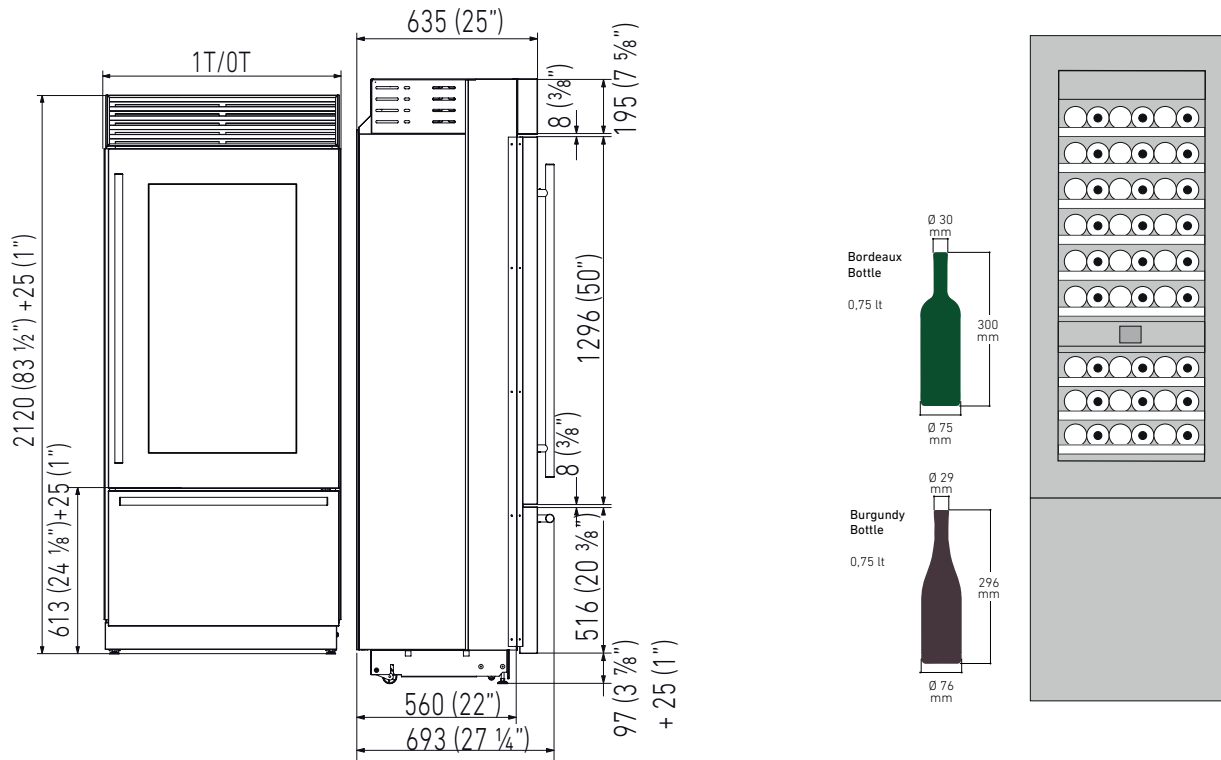

i For installation specifications, please consult with Fhiaba. For optimum installation, we recommend using the actual product as the best guide.

i Based on the adjustment of the feet and the height of the panel from the floor, the customer defines the perforated plinth to be installed on the equipment.

XS5991TWT3

60 cm, DUAL COMPARTMENT WINE CELLAR, 1T Model

BUILT-IN

X-PRO® SERIE

NICHE SPECIFICATIONS AND DIMENSIONS

Fhiaba

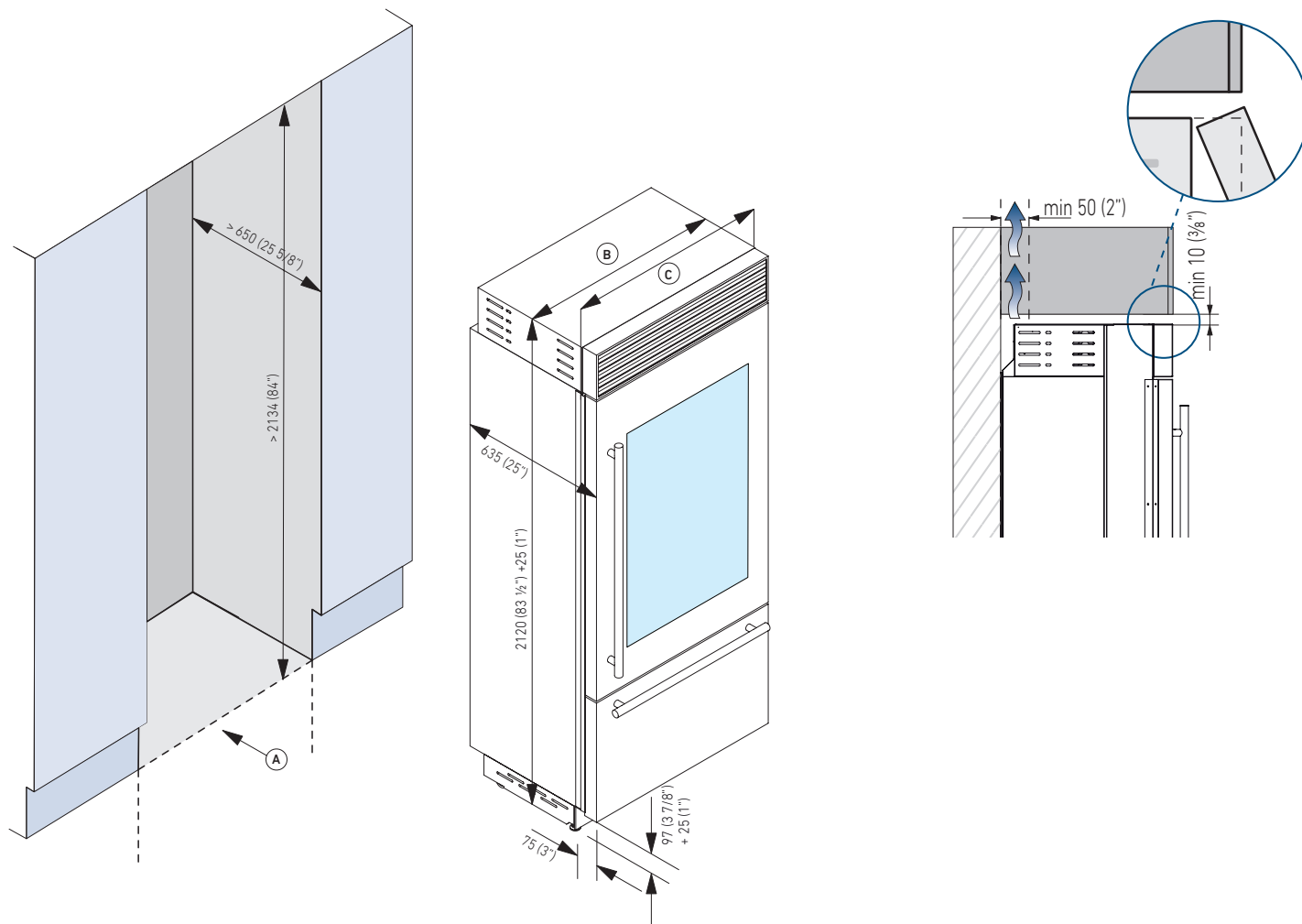

TECHNICAL DATA	
Niche Width A (mm)	600
Unit Width B (mm)	587
Unit Width with lateral frames C (mm)	599

Electrical and Water connection

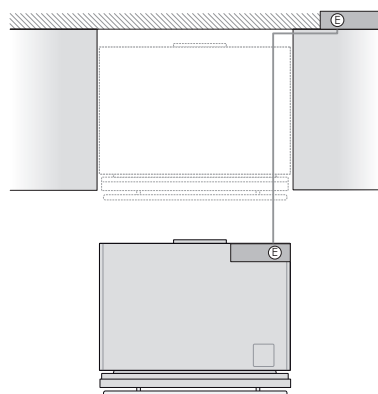

Electrical and Water connection behind the unit

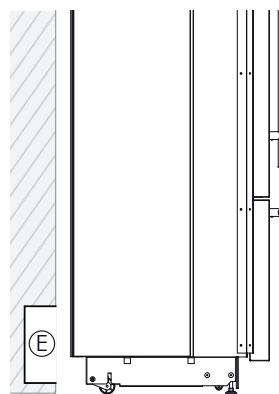

XS5991TWT3

60 cm, DUAL COMPARTMENT WINE CELLAR, 1T Model

BUILT-IN

X-PRO® SERIE

INSTALLATION INFORMATION

Fhiaba

Side by side installation

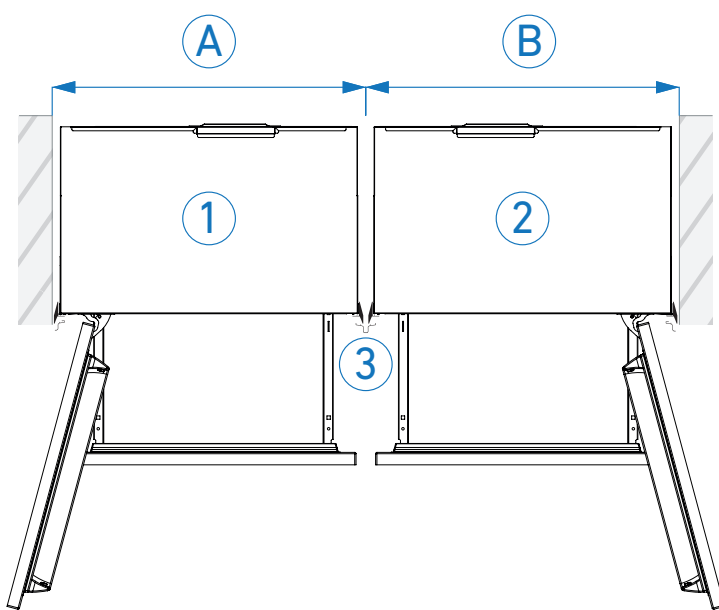

- 1 - Device 1
- 2 - Device 2
- 3 - Joining kit
- A - Niche device 1
- B - Niche device 2

ACCESSORIES

- Stainless steel sides panels
- Glass door
- Joining kit
- X-Pro top grille kit
- Extra length anti-tipping kit
- Anticondensation kit
- Cleaning kit
- Active carbon filter
- FLD - Fhiaba Link Device
- Painting
- 90° Door stop
- Wine kit
- Cheese drawer
- Set of knives
- Bottle trap
- Sigar drawer
- Beverage drawer
- Beverage shelf
- Beverage removable shelf
- Chocolate kit

 For installation specifications, please consult with Fhiaba. For optimum installation, we recommend using the actual product as the best guide.

   
www.fhiaba.com