

# XS7490HWT6

75 cm, DUAL COMPARTMENT WINE CELLAR, 0H Model

BUILT-IN

X-PRO® SERIE

*Fhiaba*



## FEATURES

- Made in Italy.
- Aisi 304 stainless steel body.
- Stainless steel interior finish
- Antibacterial stainless steel interior.
- Provent ventilation system encourages uniform distribution of cold air in all fridge compartments by laterally circulation air.
- Equilance: dual - movemenet patented hinge with self - balancing movement ensures stability and resistance.
- Optiview: multi - LED light array (top and side interior) provides brilliant illumination to the entire interior.
- Smart touch TFT display
- Acoustic and visual signals
- Total no frost 100% automatic system
- Insulated variavle speed compressors manteins precision temperature control with low vibration.
- Sabbath mode
- Front and rear adjustable feet up to 25 mm.
- Two indipendent climatic zone.
- Deep capacity within a standard depth is achieved by a side - mounted evaporators, wich leaves grater interior space.
- Full range of models and configurations ( 45, 60, 75 and 90 cm). Can easily be combined and configured with other Fhiaba fridge, freezer, wine cellar models to fit your kitchen needs.
- Triple-pane, bronzed glass door guarantees maximun protection from harmful UV light rays.
- Soft - close mechanisms on every oak wine rack.
- Humidity control
- Ambra light LED: not interact at the molecular level with the wine and not contains ultraviolet rays.

## GENERAL PROPERTIES

Reversible door	NO
Equilance	YES
SoftClosing Runner	YES
Low vibration	YES
Optiview (LED light spots)	YES
Shelves	9
Slide-out shelves	YES
Type of shelves	WOOD
Door Bins	
Fridge drawers type	
Fresco/LowTemp Drawers	
Bottom drawers	2
Full Extension shelves 90° door opening	YES
Full Extension drawers 90° door opening	NO
Defrost Process	AUTOMATIC
Ice maker with water filter	NO
Door Open Alarms	YES
Humidity control	YES
Active carbon filter	YES
Air filter control	NO
Shopping Fridge	NO
Shopping Freezer	YES
Power Failure Function	YES

# XS7490HWT6

75 cm, DUAL COMPARTMENT WINE CELLAR, 0H Model

BUILT-IN

X-PRO® SERIE

## PRODUCT DETAIL

*Fhiaba*

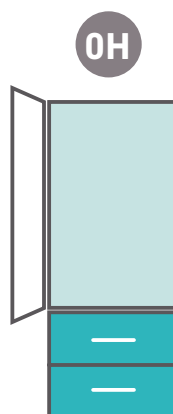
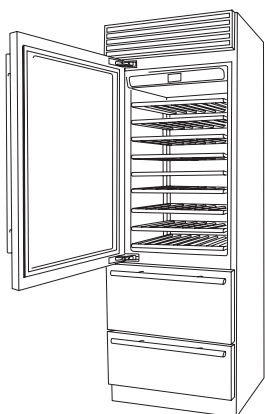

1D | 2BD | 2M

D = door

BD = drawer

M = separate microclimates

### CAPACITY

Volume Compartment 1 (L)	283
Volume Compartment 2 (L)	
Volume Compartment 3 (L)	134
Total Net Volume (L)	416
Total Gross Volume (L)	430
Compartment 1 / Upper wine cellar capacity (bottles)	81
Compartment 2 / Lower wine cellar capacity (bottles)	
Compartment 3 / Bottom wine cellar capacity (bottles)	

### TECHNICAL DETAILS

Absorbed power (W)	
Total absorbed current (A)	1.1
Voltage (V)	220-240V
Frequency (Hz)	50-60 Hz
Power Cord Length (mm)	2
Plug Type	Schuko 16A
Climatic class	SN/T
Noise level (dB)	41
Refrigerant (gas)	R600a
Water connection / female attachment	-

### EFFICIENCY

New Energy Label class	G
Energy consumption (kWh/year)	183

### DIMENSIONS & WEIGHT

Height of the product (closed weels) (mm)	2120
Adjustable feet height (mm)	25
Width of the product (mm)	749
Depth of Product without handle (mm)	635
Wall cavity height (mm)	2134
Wall cavity width (mm)	750
Wall cavity depth (mm)	650
Net Weight (kg)	200
Gross Weight (kg)	221

### TEMPERATURE RANGES

Climatic compartments	2
Compartment 1 / Upper temperature (°C)	from 4 to 18
Compartment 2 / Middle temperature (°C)	
Low temp zone	NO
Compartment 3 / Low temperature (°C)	from 4 to 18
Dual zone	YES

# XS7490HWT6

75 cm, DUAL COMPARTMENT WINE CELLAR, 0H Model

BUILT-IN

X-PRO® SERIE

## PRODUCT SPECIFICATIONS AND DIMENSIONS

*Fhiaba*

### FRONT VIEW

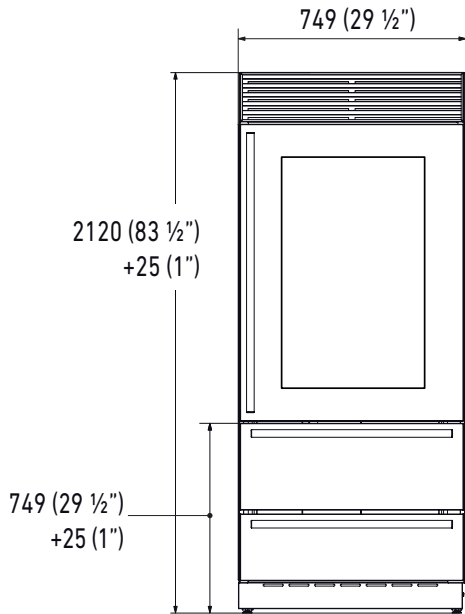

### SIDE VIEW

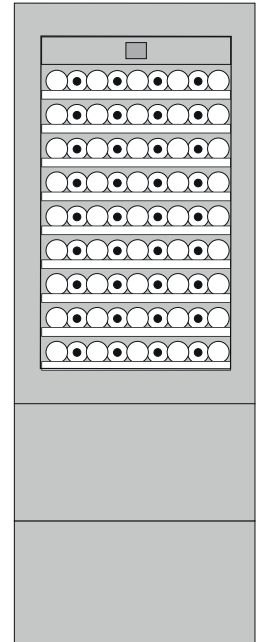
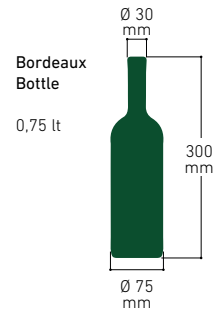
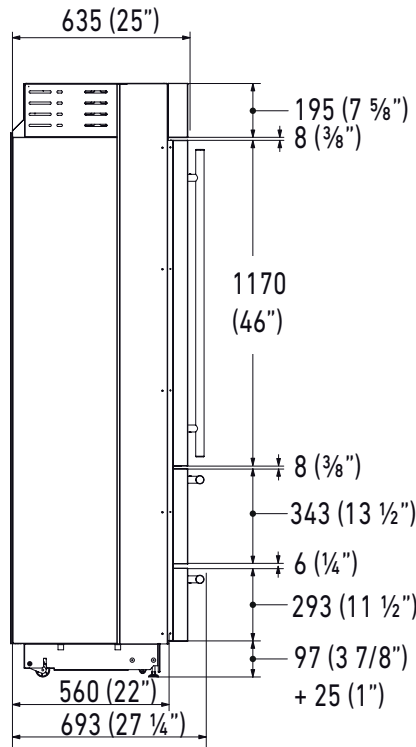

### TOP VIEW, HINGE 105°

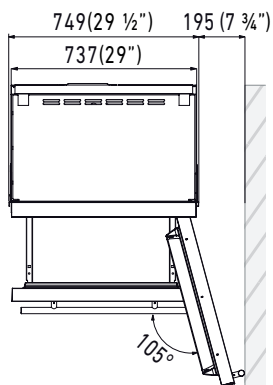

### TOP VIEW, HINGE 90°

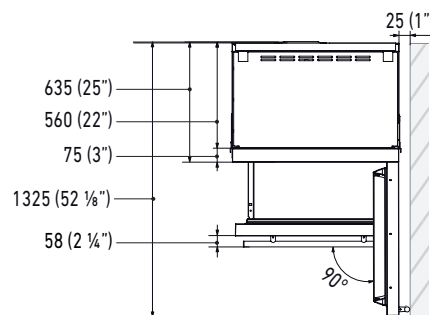

### PLINTH SIZE

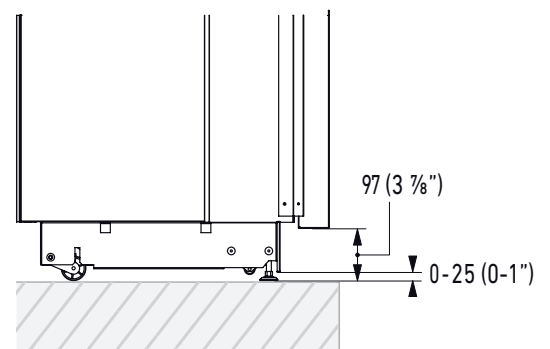

**i** For installation specifications, please consult with Fhiaba. For optimum installation, we recommend using the actual product as the best guide.

**i** Based on the adjustment of the feet and the height of the panel from the floor, the customer defines the perforated plinth to be installed on the equipment.

# XS7490HWT6

75 cm, DUAL COMPARTMENT WINE CELLAR, 0H Model

BUILT-IN

X-PRO® SERIE

## NICHE SPECIFICATIONS AND DIMENSIONS

*Fhiaba*

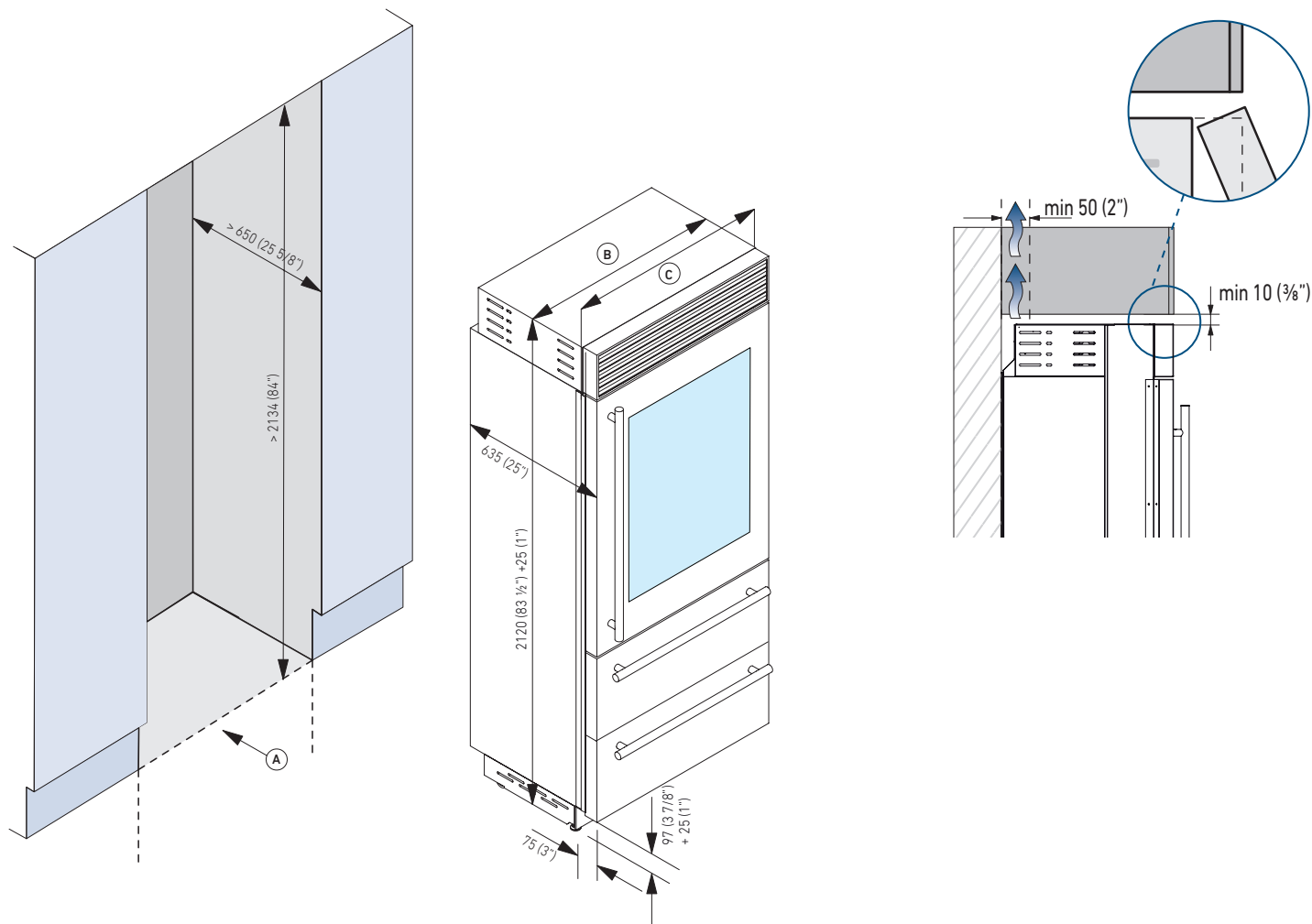

TECHNICAL DATA	
Niche Width <b>A</b> (mm)	750
Unit Width <b>B</b> (mm)	737
Unit Width with lateral frames <b>C</b> (mm)	749

### Electrical and Water connection

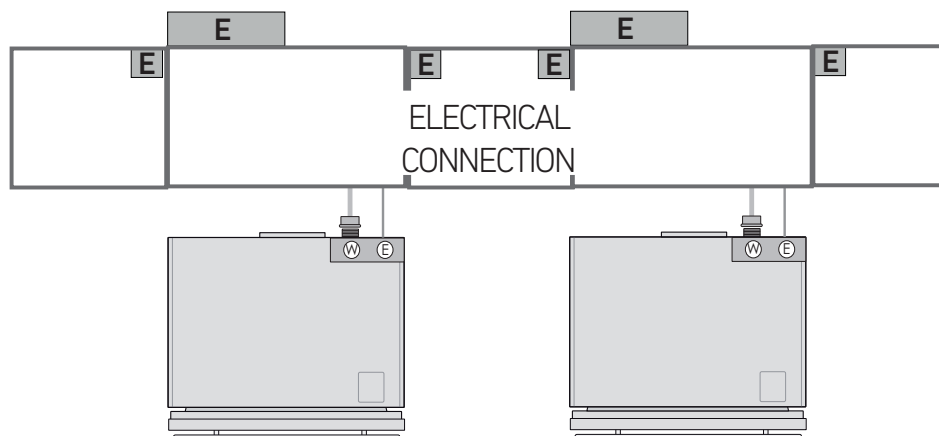

# XS7490HWT6

75 cm, DUAL COMPARTMENT WINE CELLAR, 0H Model

BUILT-IN

X-PRO® SERIE

## INSTALLATION INFORMATION

*Fhiaba*

### Niche dimensions for combined installation



		A			
	unit size	45	60	75	90
B	45	90 cm	105 cm	120 cm	135 cm
	60	105 cm	120 cm	135 cm	150 cm
	75	120 cm	135 cm	150 cm	165 cm
	90	135 cm	150 cm	165 cm	180 cm

### ACCESSORIES

- Stainless steel sides panels
- Glass door
- Joining kit
- X-Pro top grille kit
- Extra length anti-tipping kit
- Anticondensation kit
- Cleaning kit
- Active carbon filter
- FLD - Fhiaba Link Device
- Painting
- 90° Door stop
- Wine kit
- Cheese drawer
- Set of knives
- Prosciutteria kit
- Bottle trap
- Sigar drawer
- Beverage drawer
- Beverage shelf
- Beverage removable shelf

 For installation specifications, please consult with Fhiaba. For optimum installation, we recommend using the actual product as the best guide.

     
[www.fhiaba.com](http://www.fhiaba.com)